

ETF 80 Heat BlackLine

CLOTHES DRYER INSTRUCTION MANUAL

- Always read the safety&use instructions carefully before using your appliance for the first time. The user's manual must be always included.

SAFETY INSTRUCTIONS

Read carefully and save for future use!

Warning: The safety measures and instructions, contained in this manual, do not include all conditions and situations possible. The user must understand that common sense, caution and care are factors that cannot be integrated into any product. Therefore, these factors shall be ensured by the user/s using and operating this appliance. We are not liable for damages caused during shipping, by incorrect use, voltage fluctuation or the modification or adjustment of any part of the appliance.

To protect against a risk of fire or electric shock, basic precautions shall be taken while using electrical appliances, including the following:

1. Make sure the voltage in your outlet corresponds to the voltage provided on the appliance label and that the socket is properly grounded. The outlet must be installed in accordance with applicable electrical codes according to EN.
2. Do not operate the device if the cord is damaged. All repairs or adjustments including cord replacements must be carried out by a professional service centre! Do not remove the protective covers from the appliance; there is a risk of electric shock!
3. Do not plug and unplug the power cord from the outlet using wet hands. You will avoid risk of electric shock.
4. Do not touch the appliance with wet hands or feet.
5. The power cord must remain accessible once the device is installed. Do not shorten the cable and do not use power strips, adapters, or extension cords. Do not allow the cord to touch hot surfaces or place the cord over sharp edges.
6. Do not switch the device on or off by inserting or pulling out the power cable plug. Do not remove the power cord from the outlet by yanking the cord. Unplug the power cord from the outlet by grasping the plug.

7. Disconnect the dryer if not in use for a long time, and before installation, maintenance, cleaning and repair, otherwise it may be damaged.
8. The appliance must not be powered by an external switching device, such as a timer, or connected to a circuit that is periodically switched on and off.
9. Any intervention in the appliance by a person other than an authorized service provider results in loss of warranty.
10. The warranty does not cover damage caused by outside effects (flood, chemicals, fire, etc.).
11. The manufacturer is not liable for any damage caused by improper grounding/use. DANGEROUS VOLTAGE, RISK OF INJURY!
12. This appliance can be used by children aged 8 years and older and people with lower physical or mental abilities or lack of experience and knowledge, if they are supervised or have been instructed to use the product in a safe manner and understand the potential dangers. Cleaning and maintenance performed by the user should not be done by children unless they are older than 8 years and under supervision. Children under 8 years old must keep away from the appliance and its power supply. Children may not play with the appliance.
13. This dryer is intended for domestic and internal use only. The warranty will be void in the event of commercial use.
14. Use this product only for laundry with a label that indicates it is suitable for drying.
15. The manufacturer is not liable for any damage caused by improper use or transportation.
16. Do not allow floor coverings to obstruct ventilation openings.
17. Installation and repairs of the appliance may only be carried out by an authorized service centre. The manufacturer is not liable for any damage caused by unauthorized repairs.

WARNING: Never splash or pour water into the dryer to wash it! There is a risk of electric shock!

18. Leave at least 3 cm of space between the side and rear walls of the product. This also applies to the top, if you plan to place the appliance under the worktop.
19. Assembly / disassembly in the case of under the worktop installation must be carried out by an authorized service technician.
20. Check that the product is not damaged before installation. Never install and operate a damaged product.
21. Keep pets away from the dryer.
22. This device may not be used by persons (including children) with limited physical, sensory or mental capabilities, or persons without appropriate knowledge and experience, unless supervised or instructed in the use of this device by a person responsible for their safety.
23. Do not leave children unattended near the appliance.
24. Children under 3 years of age should be kept away unless they are supervised at all times.
25. Children could get stuck in the appliance, with risk of death. Do not allow children to touch the glass door when the appliance is operating. The surface becomes extremely hot and can cause skin damage.
26. Keep packaging material out of the reach of children.
27. Poisoning and irritation may occur if the washing and cleaning detergents are consumed or come into contact with skin and eyes. Keep cleaning products out of the reach of children. Electrical products are dangerous to children.
28. Keep children away from the product when in use.
 - You can use the child lock to avoid to prevent children from interrupting the drying cycle and changes in the running program.
 - Do not allow children to sit on or inside the product.Children under 3 years of age should not be allowed access unless they are under constant supervision.
29. Due to the risk of fire, the following clothes and products must NEVER be dried in the dryer:
 - Do not dry unwashed laundry in the dryer.

- Laundry that has been soiled with materials such as cooking oil, acetone, alcohol, gasoline, kerosene, stain remover, turpentine, wax, and wax remover must be washed in hot water with extra amount of detergent before drying in the dryer.
- Dishtowels and mats that have residues of flammable cleaning agents or acetone, gas, kerosene, stain remover, turpentine, candles, wax, wax removers or chemicals.
- Laundry that has hair spray remnants, nail polish removers, and the like.
- Laundry on which industrial cleaning chemicals have been used (for example, dry cleaning).
- Laundry, which contains any kind of foam, rubber or rubber part. These include foam rubber (latex foam), bathing caps, waterproof textiles, clothing or cushions with rubber support or rubber foam items.
- Items with fills and damaged items (pillows or jackets). The foam rising from these articles may ignite during drying.
- Operating the dryer in environments that contain coal or flour dust may cause an explosion.

WARNING: Underwear that contains metal reinforcement must not be dried in the dryer. The dryer may be damaged if the metal parts are loosened or broken when dried.

30. Fabric softeners or similar products must be used in accordance with the manufacturer's instructions as specified in the fabric softener's instructions.

- Remove all objects from the pockets, e.g. lighters and matches.

This product contains an environmentally safe but flammable gas R290. Protect the product from open flames and sources of fire.

WARNING: Never stop the appliance until the drying program stops. If you have to stop the appliance, remove the laundry quickly and unfold it so that it cools down.



Risk of fire and damage!

WARNING: Make sure pets can not get into the dryer. Look inside the dryer before use.

WARNING: The laundry in the dryer may overheat if the program is stopped or in the event of a power failure while the dryer is running. This concentration of heat can cause spontaneous combustion, so always run the Refresh program to cool the laundry or quickly remove any laundry from the dryer and hang it to cool it.

Only use the dryer for drying at the home and for drying fabrics marked as suitable for drying. All other uses are outside the intended use range and are prohibited. The warranty will be void in the event of commercial use.

This appliance is intended for domestic use only and should be placed on an even and stable surface.

- Do not sit or lean on the dryer door. The dryer could tip over.
- To maintain the temperature that does not damage the laundry (e.g. to prevent the ignition of the laundry), the cooling process starts after heating. Then the program ends. Always remove the laundry immediately at the end of the program.

WARNING: Never use the dryer without a textile fibre filter or with a damaged filter.

The textile fibre filters must be cleaned after each use as described in section Cleaning the textile fibre filter.

The textile fibre filters should be dried after wet cleaning. Wet filters could cause a malfunction during drying.

You must not allow the accumulation of fibres around the dryer's drum (not applicable to appliances, which are ventilated to the exterior of the building)

INSTALLATION

In the room where the appliance is to be installed, there must be no lockable, sliding doors or hinged doors on the opposite side of the tumble dryer door, which could block the full opening of the dryer's door.

WARNING: Keep the air vents unobstructed in the appliance cabinet or a built-in structure.

Before calling the nearest authorized service center for the dryer installation, make sure that the electrical installation and water drain are suitable and in accordance with the instruction manual. If not, contact a qualified electrician and plumber to take the necessary measures.

It is the customer's responsibility to prepare the location for the dryer, as well as the electrical installation and wastewater installation. Check that the dryer is not damaged before installation. Do not install the dryer if it is damaged. Damaged products can endanger your health.

Install the dryer on a stable, level surface.

Use the dryer in a well-ventilated, dust-free environment.

Do not reduce the space between the dryer and the floor with materials such as carpets, boards and mats.

Do not cover the ventilation grilles located on the dryer stand.

- After installing the dryer, leave it in the same place where it was connected. When installing the dryer, make sure that its rear wall does not touch anything (tap, socket, etc.).
- The operating temperature of the dryer is from +5°C to +35°C. When operating outside this temperature range, the performance of the dryer will be negatively affected and the product will be damaged.
- Be careful when transporting the product because it is heavy. Always use protective gloves.
- Always install the dryer at a wall.
- The rear of the dryer must be positioned against the wall.
- If the dryer is placed on a stable surface, use a spirit level to check that it is fully stable. If it is not, adjust the feet until the dryer is stable. Repeat this procedure each time the dryer is moved.
- Do not place the dryer on the power cable.

IMPORTANT NOTE: Do not reduce the gap between the dryer and the floor with materials such as carpets, boards and mats, otherwise the air dryer will not receive sufficient air intake.

Do not place the dryer in rooms where there is a risk of freezing. Freezing temperatures negatively affect the dryer's performance. Condensed water that freezes the pump and hose can cause damage.

Installation above the washing machine

WARNING: You cannot place a washing machine on the dryer. Observe the following precautions when installing the dryer above the washing machine.

WARNING: The dryer can be only placed on washing machines that have the same or greater capacity.

In order to be able to use the dryer on the washing machine, a strengthening part must be provided between the two products. This strengthening part has to be installed by an authorized service technician.

When the dryer is placed on a washing machine, the total weight of these products can reach nearly 150 kilograms (fully loaded). Place the appliances on a solid floor that has sufficient load capacity!

Installation table for washing machine and dryer					
Dryer (Depth)	Washing machine				
	37-41 cm	42-45 cm	46-49 cm	50-56 cm	57-63 cm
52.5 cm	X	✓	✓	✓	✓
56 cm	X	X	✓	✓	✓
61 cm	X	X	X	✓	✓
64 cm	X	X	X	X	✓

Drain connection (with optional drain hose)

In products equipped with a heat pump the water accumulates in the water tank during the drying cycle. You must drain the accumulated water after each drying cycle. You can drain the accumulated water directly into the drain through the drain hose that is supplied with the appliance instead of regularly pouring out the water collected in the water tank.

Connecting the drain hose

1. Pull out and remove the hose end from the rear of the dryer. Do not use any tools to remove the hose.
2. Connect one end of the drain hose supplied with the dryer to the connection point from which you removed the hose in the previous step.

3. Connect the other end of the drain hose directly to the drain or sink.

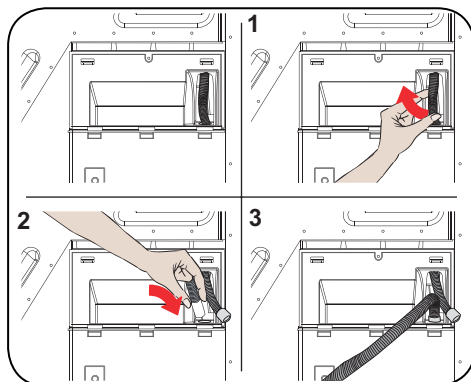

WARNING: The hose must be connected so that it can not come loose. If the hose is disconnected during draining, the house may be flooded.

IMPORTANT NOTE: Fasten the drain hose at the maximum height of 80 cm.

IMPORTANT NOTE: Make sure that the drain hose is not bent and is not wedged between the drain and the appliance.

Adjusting the feet

- To operate the dryer with less noise and vibration, it must be stable and balanced on the feet. Adjust the feet to ensure the proper product balance.
- Turn the feet to the left or right until the dryer is in a horizontal position.

IMPORTANT NOTE: Never remove the adjustable feet.

Electrical wiring

WARNING: There is a risk of electric shock.

- Your dryer is set to use 220-240 V and 50 Hz.
- The dryer power cable is equipped with a special connector. This connector must be connected to a grounded socket protected by a 16 amperes fuse as indicated on the rating plate. The fuse for short-circuit protection of the power line where the socket is connected must also be 16 amperes. If you do not have such a socket or fuse, contact a qualified electrician.
- Our company is not liable for damages caused by use without grounding.

IMPORTANT NOTE: Operating the equipment at low voltage will shorten the life and reduce the performance of your appliance.

Installation under the worktop

- Leave at least 3 cm of space between the side and rear walls of the product. This also applies to the top wall if you intend to install the appliance under the worktop.
- Assembly / disassembly in the case of under the worktop installation must be carried out by an authorized service technician.

DESCRIPTION

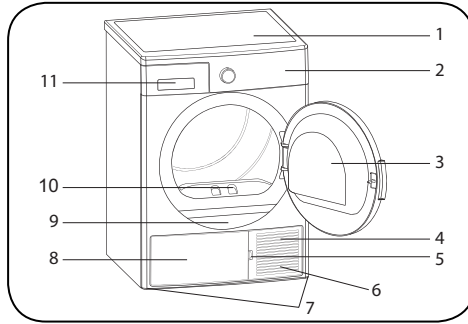

















1. Top plate
2. Control panel
3. Door
4. Heat exchanger
5. Exchanger door fuse
6. Ventilation grilles
7. Adjustable legs
8. Exchanger door
9. Rating plate
10. Textile fibres filter
11. Water tank

LAUNDRY PREPARATION

Sorting laundry for drying

Always follow the instructions on the garment labels. Dry only the laundry with a label indicating that it is suitable for drying in the dryer.

- Do not use the dryer with the quantity and types of laundry, which are not listed in section „Kapacita sušičky“.

 Suitable for tumble drying	 Ironing is not necessary	 Delicate/Fine drying	 Not suitable for dryer
 Do not dry	 Do not dry clean	 At any temperature	 At high temperatures
 At medium temperatures	 At low temperatures	 Without heating	 Hang to dry
 Spread to dry	 Hang wet to dry	 Spread to dry in the shade	 Suitable for dry cleaning

Do not dry thin, multi-layered, or thick fabrics together as they dry at different temperatures. For this reason, dry together the garments of the same fabric structure and type. This ensures uniform drying. If you think the laundry is still wet, you can choose a time program for further drying.

Please dry large items (such as bedding) and small items separately so that you don't have damp clothes.

IMPORTANT NOTE: Wool, silk clothing, fine and valuable fabrics, airtight pieces and tulle curtains are not suitable for machine drying.

Preparing laundry for drying



Danger of explosion and fire!

Remove all objects such as lighters and matches from your pockets.

WARNING: The dryer drum and the fabric can be damaged.

- The laundry after washing can be entangled with each other. Separate the laundry items before placing them in the dryer.
- Remove all items from your pockets and do the following:
- Tie together the textile straps, apron strings and the like, or use a laundry bag.
- Fasten the zippers, buckles and fasteners, and the buttons on the bed linen.
- To get the best drying result, sort the laundry by the type of fabric and drying program.
- Remove clips and similar garment metal parts.
- Fabrics such as t-shirts and knitted garments usually shrink when first dried. Use a protective program.
- Do not overdry synthetics. This causes the laundry to be wrinkled.
- When washing the laundry you want to dry, adjust the fabric softener according to the washing machine manufacturer's instructions.

Dryer capacity

Follow the instructions in section „Tabulka programů a spotřeby“. Do not load more than is the capacity listed in the table.



IMPORTANT NOTE: We do not recommend to load the dryer with the amount of laundry exceeding the value shown in the picture. If the appliance is overloaded, its drying performance is reduced. In addition, the dryer and laundry may be damaged.

Laundry	Dry laundry weight (g)
Bed linen (double)	725
Pillow case	240
Dishtowels	700
Towels	225
Shirts 190	190
Cotton shirts	200
Jeans	650
Linen pants	400
T-shirts	120

USE OF THE DRYER

Control panel

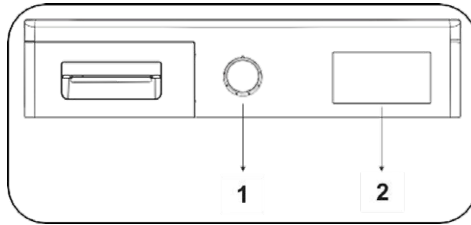

1. Rotary programme selector
2. Electronic display and additional functions

Rotary programme selector

Use the selector to choose the desired drying programme

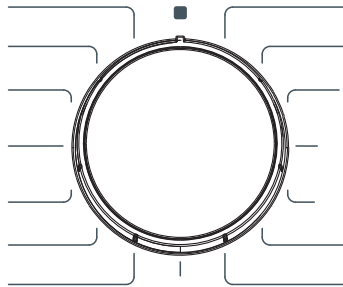

Display and additional functions*

Button 1: Delayed start

Button 2: Drying level

Button 3: Gentle drying (sound signal off - hold for approx. 3 seconds)



Press buttons 2 and 3 simultaneously: Child lock

Button 4: Start/Pause

* Additional features may vary depending on the model.



Screen symbols:

Water tank alert indicator	
Indicator for textile fibre cleaning alert	
Indicator alert for cleaning the heat exchanger	

Program and consumption table

Press the Start/Pause button to start the program. The Start/Pause indicator shows that the program has started and the drying light indicator comes on.

Programme		Load (kg)	Spinning speed in the washing machine	Approximate amount of moisture remaining	Drying time (minutes)
Cotton	Extra drying	8	1000	60 %	198
	For the closet	8	1000	60 %	189
	For ironing	8	1000	60 %	156
Synthetics	For the closet	4	800	40 %	80
	For ironing	4	800	40 %	59
Delicates		2	600	50 %	55
Mix		4	1000	60 %	115
Baby clothes		3	1000	60 %	86
Jeans		4	1200	60 %	125
60 min		-	-	-	60
40 min		-	-	-	40
20 min		-	-	-	20
Refresh		-	-	-	10
Express 34'		1	1200	50 %	34
Shirts 20'		0.5	1200	50 %	20

Energy consumption values				
Programme	Load (kg)	Spinning speed in the washing machine	Approximate amount of moisture remaining	Energy consumption values (kWh)
Cotton to Closet	8	1000	60 %	1.91
Cotton for ironing	8	1000	60 %	1.47
Synthetics for the closet	4	800	40 %	0.78
Energy consumption in the "Off" mode P_o (W)				0.5
Energy consumption in the "On" mode P_t (W)				1



The "Cotton to Closet" program used at full and partial load is the standard drying program for which information on the label and information sheet is relevant. This program is the most energy efficient program for drying normal wet cotton laundry.

* Energy label standard program (EN 61121: 2013)

All values in the table have been determined in accordance with EN 61121: 2013. Consumption values may differ from the values in the table depending on the type of fabric, the method of spinning, ambient conditions and variations in voltage.

Additional functions

The table below summarizes the options that can be selected in the programs is provided below.

Option	Description
Gentle drying	Delicate fabrics are dried for a longer period of time at a low temperature.
Drying level	The humidity obtained after drying can be increased up to 3 levels above the standard setting. In this way, the desired level of residual moisture can be selected. Once selected, the corresponding drying level indicator lights up - 1,2 or 3.
Delayed start	You can delay the start time of the selected programme by 1 to 23 hours. The desired delayed start time can be activated by pressing the Start/Pause button. After the set time has elapsed, the selected programme will start automatically. During the delay period, options compatible with the program can be activated/deactivated. By holding down the "Delayed start" button you can change the delay time repeatedly.
Canceling the sound alert	Cancels all sound signals (when turning the programme selection knob, button sounds and end of programme notifications). To cancel the audible alert, press the number.5" button for 3 seconds. When you press the button, you will hear a sound alert that this option is cancelled. Press button 5 again for 3 seconds to resume the audio signals.

Option	Description
Child lock	<p>The appliance is equipped with a child lock to prevent changing the current program. The child lock is activated by pressing buttons 4 and 5 at the same time for about 3 seconds.</p> <p>If the child lock is activated, all buttons will be deactivated. WARNING: The child lock is not automatically deactivated when the programme is finished. To deactivate the child lock, turn the selector lever to OFF.</p> <p>Then rotate them to the first position (program 1). The child lock is still active. To deactivate the child lock, press buttons No. 4 and 5 simultaneously for approx. 3 seconds. When the child lock is activated/deactivated, the display will show "CL" for 2 seconds and an audible warning will sound. Warning: When the dryer is in operation or the child lock is active and you turn the program selection knob, you will hear an audible warning and the display will show "CL" for 2 seconds</p> <p>If you turn the programme selection knob, an audible warning sounds. Even if you set the program selection knob to a different program, the previous program will continue to run. To select a new programme, you must deactivate the child lock and then adjust the programme selection knob.</p>

Program start

The Start/Stop LED flashes during program selection. Press the Start/Pause button to start the selected program. The Start/Pause LED lights up to indicate that the selected program is running. At the same time, the drying LED lights up.

Programme	Description
Cotton Extra Drying	This programme dries high weight or multi-ply fabrics (e.g. cotton towels, bed linen, pillows, bathrobes) at high temperature. The dried laundry can be stored directly in the wardrobe.
Cotton to Closet	This programme dries cotton pyjamas, underwear, tablecloths etc. This way, you can store the dried linen directly in the wardrobe.
Cotton for ironing	This program dries cotton linen and prepares it for ironing. Laundry dried in this way is damp when the cycle is complete, but irons better.
Synthetics to Closet	This program dries synthetic materials such as shirts, t-shirts, blouses, at a lower temperature compared to a cotton program, and allows you to place the clothes in the closet.
Synthetics For ironing	This programme dries synthetic materials such as shirts, T-shirts and blouses at a lower temperature than cotton programmes. Laundry dried in this way is damp when the cycle is complete, but irons better.
Delicates	This program dries thin clothing such as shirts, blouses and silk garments at low temperature to be ready for wear.
Mix	This programme dries garments made from a mixture of cotton and synthetic materials that are not dyed, so that they are ready to wear immediately.
Baby clothes	This programme dries delicate baby and children's clothes at a low temperature so that they are ready for immediate wear.
Jeans	Programme for drying jeans
60 min.	Drying at low temperature. Regardless of the drying level, the programme will stop at the desired time.
40 min.	
20 min.	
Refresh	The drying time can be selected between 10 and 120 minutes without hot air supply. This refreshes the laundry and eliminates odours.

Programme	Description
Express 34'	1 kg of cotton shirts, washed at high speed in the washing machine, will be dry in 34 minutes.
Shirts 20'	2 to 3 shirts will be ready for ironing in 20 minutes.

IMPORTANT NOTE: Do not open the door when a program is running. If you have to open the door, do not leave it open too long.

Selecting the standby mode

After 15 minutes without intervention in the program selection, the device enters energy saving mode to reduce energy consumption. For this model, the "- - -" indication will flash as follows during power saving mode: 0.5 s on, 3 s off. In power saving mode, the "- - -" indication will decrease in luminance. To restart the device, you must switch the selector switch to OFF and select the program again.

Program progress

During program

If you open the door while the program is running, the dryer will switch to standby mode. After closing the door, press the Start/Pause button to continue the program.

Do not open the door when a program is running. If you have to open the door, do not leave it open too long.

End of program

When the program is over, the indicator lights of Start/Pause, the water tank level, the filter cleaning and the heat exchanger will light up. In addition, an alert will be sound at the end of the program. You can remove the laundry to prepare the dryer for a new batch.

IMPORTANT NOTE: Clean the filter after each program. Empty the water container after each program.

IMPORTANT NOTE: if you do not remove the laundry after the end of the program, the 1 hour Anti Crease phase is activated. This program rotates the drum at regular intervals to prevent wrinkling.

Information about the drum light

- This appliance is equipped with a LED light located in the drum. The LED lights up automatically when you open the door. It automatically goes off after a while.
- The user can not set up turning the light on or off by himself.
- Do not try to replace or modify the light yourself.

PROGRAM	Option				
	Delayed start	End of cycle Cancelling the sound alert	Child lock	Drying level	Delicates
Cotton Extra Drying	✓	✓	✓	✓	✓
Cotton to Closet	✓	✓	✓	✓	✓
Cotton for ironing	✓	✓	✓	✓	✓
Synthetics to Closet	✓	✓	✓	✓	✓
Synthetics For ironing	✓	✓	✓	✓	✓
Delicates	✓	✓	✓	X	✓
Mix	✓	✓	✓	✓	✓

PROGRAM	Option				
	Delayed start	End of cycle Cancelling the sound alert	Child lock	Drying level	Delicates
Baby clothes	✓	✓	✓	✓	✓
Jeans	✓	✓	✓	✓	✓
60 min	✓	✓	✓	X	X
40 min	✓	✓	✓	X	X
20 min	✓	✓	✓	X	X
Refresh	✓	✓	✓	X	X
Fast 34'	✓	✓	✓	X	X
Shirts 20'	✓	✓	✓	X	X
X	Not optional				
✓	Optional				

MAINTENANCE AND CLEANING

IMPORTANT NOTE: Do not use industrial chemicals to clean the dryer. Do not use a dryer that has been cleaned with industrial chemicals.

Cleaning the textile fibres filter

IMPORTANT NOTE: DO NOT FORGET TO LEAN TEXTILE FIBERS FILTER AFTER EACH PROGRAM RUN.

To clean the textile fibres filter:

1. Open the loading door.
2. Pull out and remove the filters.
3. Open the outer filter.
4. Use hands or soft cloth to clean the outer filter.
5. Open the inner filter
6. Use hands or soft cloth to clean the inner filter.
7. Close the filters and put the hooks back in place.
8. Place the inner filter inside the outer filter.
9. Reinstall the textile fibres filter back in place.

After using the drier for a period of time, if you encounter a layer which creates an obstacle on the top of the filter, clean the filter with warm water. Dry the filter thoroughly and reinstall it.

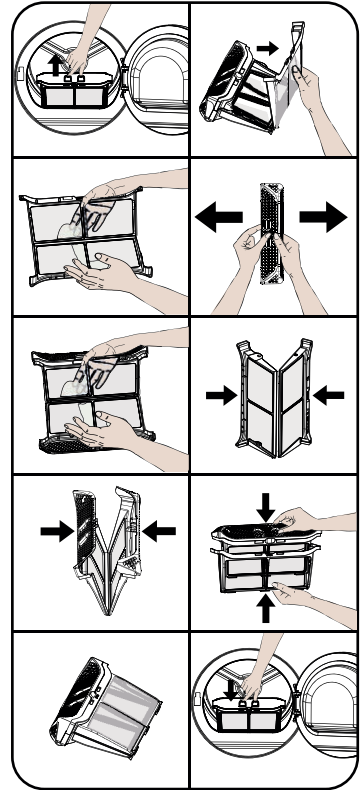
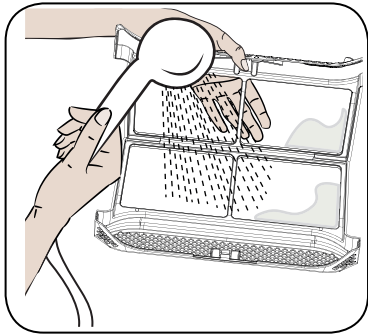

Emptying the water tank

1. Pull out the compartment cover and carefully remove the tank.
2. Empty the water from the tank.
3. If fibres collect on the tank cover, clean it with water.
4. Replace the water tank back in place.

IMPORTANT NOTE: Never remove the water tank while a program is running. Water condensed in the water tank is not suitable for human consumption.

IMPORTANT NOTE: DO NOT FORGET TO CLEAN THE WATER TANK AFTER EACH PROGRAM RUN.

Cleaning the heat exchanger

IMPORTANT NOTE: If you see warning "Heat exchanger cleaning", clean the heat exchanger.

IMPORTANT NOTE: EVEN IF THE INDICATOR "HEAT EXCHANGER CLEANING" IS NOT ON: CLEAN THE HEAT EXCHANGER AFTER EACH 30 DRYING RUNS OR ONCE A MONTH.

If the drying process is finished, open the loading door and wait until it cools.

1. Open the cover plate cover as shown.
2. Unlock the heat exchanger.
3. Remove the cover of the heat exchanger as shown in the picture.
4. Clean the front area of the heat exchanger according to the picture.
5. Install the heat exchanger cover according to the picture.
6. Lock the heat exchanger.
7. Close the cover plate according to the picture.

WARNING: THE HEAT EXCHANGER STABILIZERS ARE SHARP. DO NOT TRY TO CLEAN THEM MANUALLY. THE STABILIZERS CAN DAMAGE YOUR HANDS.

Cleaning the humidity sensor

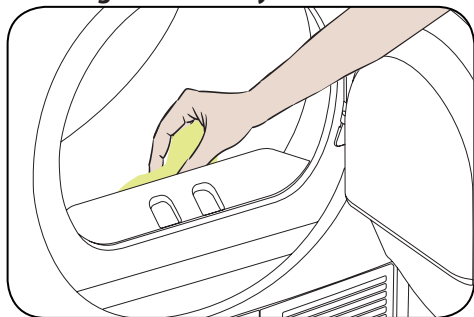

There are humidity sensors inside the appliance, which determine if the laundry is dry or not.

To clean the sensors:

1. Open the loading door.
2. If the machine is still hot due to drying, wait for it to cool.

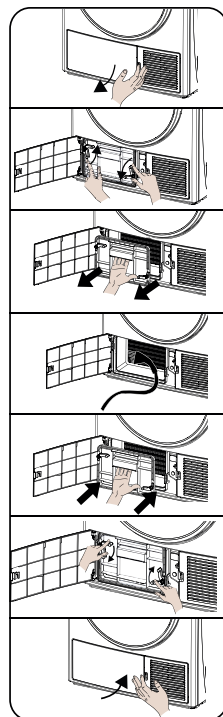
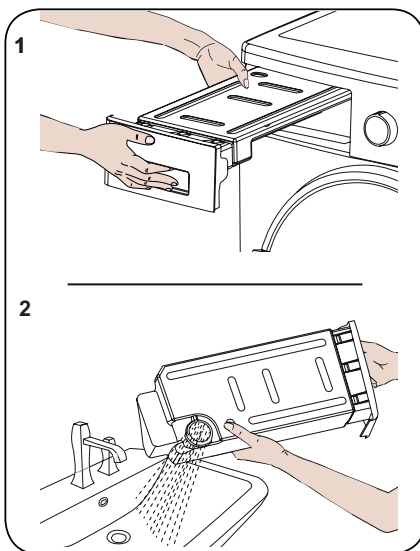

3. Use a soft cloth soaked in vinegar to wipe the sensor's metal surfaces and dry them.

IMPORTANT NOTE: CLEAN THE METAL SENSOR SURFACES 4 x A YEAR.

IMPORTANT NOTE: Do not use metal tools to clean the metal surfaces of the sensor.

WARNING: Do not use cleaning agents or similar products to clean the sensors due to the risk of fire or explosion.

Cleaning the inner surface of the loading door

IMPORTANT NOTE: DO NOT FORGET TO CLEAN THE INNER SURFACE OF THE LOADING DOOR AFTER EACH DRYING RUN.

Open the dryer loading door and clean all inside surfaces and seals with a soft, damp cloth.

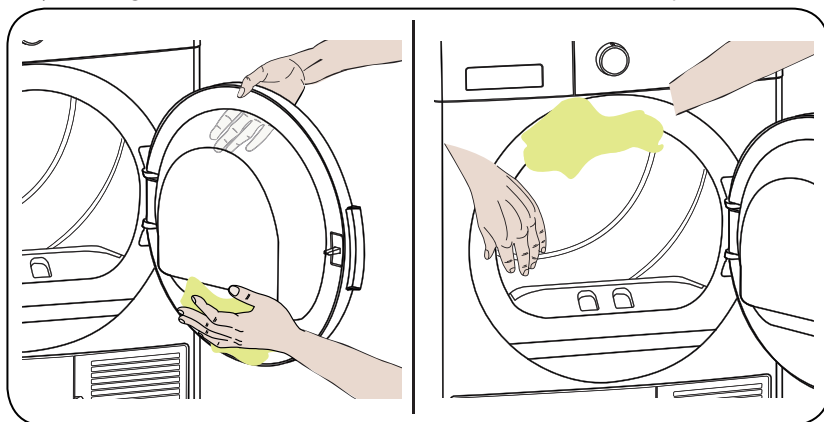

TECHNICAL SPECIFICATIONS

Brand	ECG
Model	ETF 80 Heat BlackLine
Height	Min: 845 mm / Max: 855 mm*
Width	596 mm
Depth	563 mm
Capacity (max.)	8 kg**
Net weight (with plastic door)	41.5 kg
Net weight (with glass door)	43 kg
Voltage	220–240 V
Power input	1000 W
Fuse / Total current	10 A

* Min. Height: Height with adjustable feet is not available. Max. height: Height with adjustable feet extended to maximum.

** Weight of dry laundry before washing

IMPORTANT NOTE: Technical specifications may be changed without prior notice when the quality of the dryer will be improved.

IMPORTANT NOTE: These values were obtained under laboratory conditions according to appropriate standards. These values may vary depending on environmental conditions and use of the dryer.

WARNING:

- For safety reasons, regulations require an area of at least 1 m² per 8 g of refrigerant for this type of equipment. For 110 g of propane, the minimum allowable room size would be 13.75 m³.
- Coolant: Risk of fire / poisoning risk / risk of material damage and damage to the appliance. The appliance contains coolant, R290, which is environmentally safe but flammable. Improper disposal may result in fire or poisoning. Dispose of the appliance properly and take care not to damage the refrigerant circuit.
 - Type of coolant: R290
 - Amount of gas: 110 g
 - POD (Potential ozone depletion): 0
 - PGO (Global warming potential): 3
- Risk of explosion and fire! Remove all lighters and matches from the pockets.
- Do not place the dryer next to an open flame and sources of fire.

TROUBLESHOOTING

The dryer is equipped with systems that are continuously checking during drying to take the necessary precautions and warn you of any malfunction.

WARNING: If the problem persists even though you applied the steps provided in this section, contact your vendor or an authorized service. Never try to repair a malfunctioning product.

PROBLEM	CAUSE	SOLUTION
The drying process takes a long time.	The surface of the lint filter may be clogged.	Wash the filter with lukewarm water.
	The condenser may be clogged.	Clean the capacitor.
	The ventilation grilles at the front of the machine can be closed.	Open the doors/windows so that the room temperature does not rise too much.
	There may be a layer of scale on the humidity sensor.	Clean the humidity sensor.
	The dryer may be overloaded with laundry.	Do not overload the dryer.
	The laundry may not be sufficiently spun.	Select a higher spin speed on the washing machine.
The laundry is damp at the end of the drying process.	Laundry that is hot at the end of drying is usually wetter.	
	The programme used may not be suitable for the type of laundry.	Check the care labels, select the appropriate programme for the type of laundry and use the time programmes.
	The surface of the lint filter may be clogged.	Wash the filter with lukewarm water.
	The condenser may be clogged.	Clean the capacitor.
	The dryer may be overloaded with laundry.	Do not overload the dryer.
	The laundry may not be sufficiently spun.	Select a higher spin speed on the washing machine.

PROBLEM	CAUSE	SOLUTION
The dryer cannot be opened or the program cannot be started. The dryer does not activate when set.	The dryer does not need to be plugged into the mains.	Make sure the dryer is plugged into a power outlet.
	The door may be open.	Make sure the door is closed properly.
	You may not have set the program or pressed the Start/Pause button.	Make sure that the programme has been set and that the dryer is not in standby (pause) mode.
	The child lock can be active.	Turn off the child lock.
The programme was interrupted for no reason.	The door may not be closed properly.	Make sure the door is closed properly.
	There may have been a power outage.	Press Start/Pause to start the program.
	The water tank may be full.	Empty the water tank.
Clothes have been knocked off, flattened or destroyed.	The programme used may not be suitable for the type of laundry.	Check the care labels and select the appropriate programme for the type of laundry.
Water leaking from the door.	Wrinkles may accumulate on the inner surfaces of the loading door and on the door seal surfaces.	Clean the inner surfaces of the loading door and the door seal surfaces.
The door opens by itself.	The door may not be closed properly.	Push the door until you hear it close.
The water tank warning symbol lights/flashes.	The water tank may be full.	Empty the water tank.
	The drain hose may be bent.	If the product is connected directly to a water outlet, check the water drain hose.
The condenser cleaning warning symbol lights up.	The capacitor may be unclean.	Clean the capacitor.
The filter cleaning warning symbol lights up.	The lint filter may not be clean.	Clean the filter.
	The filter seat may be clogged with lint.	Clean the filter seat.
	There may be a layer on the surface of the lint filter that causes obstructions.	Wash the filter with lukewarm water.
The program cannot be started and the filter warning light flashes	The filter seat may be clogged with lint.	Clean the filter seat.
	There may be a layer on the surface of the lint filter that causes obstructions.	Wash the filter with lukewarm water.
	The capacitor must not be placed.	Replace the capacitor.
The program cannot be started and the capacitor and filter warning light flashes	The condenser and filter must not be placed.	Replace the filter and capacitor.
	The filter and capacitor warning lights flash even when the filter and capacitor are in place.	Contact customer service.

AUTOMATIC MALFUNCTION ALERTS AND WHAT TO DO

Your tumble dryer is equipped with a built-in malfunctions detection system, which are indicated by a combination of flashing operating lights. The most common error codes are listed below.

Error code	Solution
E03 / 	Empty the water tank, if the problem persists, contact your nearest authorized service representative.
E04	Contact your nearest authorized service representative.
E05	Contact your nearest authorized service representative.
E06	Contact your nearest authorized service representative.
E07	Contact your nearest authorized service representative.
E08	There may be voltage fluctuations in the power supply. In this case, wait until the voltage value returns to the operating range.

Energy efficiency

- You should use the dryer at full power, but make sure it is not overloaded.
- When washing clothes, the spin speed should be as high as possible. This reduces drying time and reduces power consumption.
- Make sure the same types of laundry are dried together.
- When selecting a program, follow the recommendations in the instruction manual.
- Leave a suitable gap on the front and back of the dryer for air circulation. Do not cover the grilles on the front of the appliance.
- If it is not necessary, do not open the dryer door during drying. If you have to open the door, do not leave it open too long.
- Do not add new (wet) laundry during the drying run.
- The hairs and fibres that separate from the laundry and merge in the air are collected using the "Textile Fibre Filters". Make sure the filters are cleaned before and after each use.
- For heat pump models, make sure the heat pump is cleaned at least once a month or after every 30 uses.
- The environment in which the dryer is installed must be well ventilated during drying.

USE AND DISPOSAL OF WASTE

Wrapping paper and corrugated paperboard – deliver to scrapyards. Packing foil, PE bags, plastic elements – throw into plastic recycling containers.

DISPOSAL OF PRODUCTS AT THE END OF LIFETIME

Disposal of electric and electronic equipment (valid in EU member countries and other European countries with an implemented recycling system)

The represented symbol on the product or package means the product shall not be treated as domestic waste. Hand over the product to the specified location for recycling electric and electronic equipment. Prevent negative impacts on human health and the environment by properly recycling your product. Recycling contributes to preserving natural resources. For more information on the recycling of this product, refer to your local authority, domestic waste processing organization or store, where you purchased the product.



08/05

This product complies with EU directives on electromagnetic compatibility and electrical safety.



The operating manual is available on internet at www.ecg-electro.eu.
Changes of text and technical parameters reserved.

PRODUCT INFORMATION SHEET	
In accordance with Delegated Commission Regulation (EU) No 392/2012	
Supplier name or trademark	ECG
Name of the model	ETF 80 Heat BlackLine
Rated capacity (kg)	8
Dryer type	Heat pump
Energy efficiency class ⁽¹⁾	A++
Annual energy consumption (kWh) ⁽²⁾	235
Automatic/Non-automatic	Automatic
Power consumption of standard full load cotton program (kWh)	1.91
Power consumption of the standard partial load cotton program (kWh)	1.07
Off mode power consumption for standard full load cotton program P_o (W)	0.5
On mode power consumption for standard full cotton load program P_L (W)	1
Time duration in On mode (min)	not available
Standard cotton program ⁽³⁾	
Duration time of a standard full load cotton program T_{drying} (min.)	189
Duration time of a standard partial load cotton program $T_{\text{drying } 1/2}$ (min.)	113
Duration time of a standard full and partial load cotton program (T_t)	146
Condensation efficiency class ⁽⁴⁾	B
The average condensation efficiency of a standard full load cotton program C_{drying}	81 %
The average condensation efficiency of a standard partial load cotton program $C_{\text{drying } 1/2}$	81 %
Weighted condensation efficiency of a standard full and partial load cotton program C_t	81 %
The sound power efficiency level of a standard full load cotton program ⁽⁵⁾	65
Built-in	No

- (1) Scale from +++ (most effective) to D (least effective)
- (2) Energy consumption is based on 160 standard cycles of standard cotton program at full load, partial load, and low power consumption modes. The actual energy consumption per cycle depends on how the appliance is used.
- (3) The "Closet Drying Program" used at full and partial load is a standard drying program that is subject to the information on the label and information sheet. This program is suitable for drying normal wet cotton laundry and is the most efficient program for energy consumption for cotton.
- (4) Scale from G (least effective) to A (most effective)
- (5) Weighted average value – L wA expressed in dB (A) re 1 pW

www.ecg-electro.eu

- The manufacturer takes no responsibility for printing errors contained in the product's user's manual.